

Filtri di aspirazione e mandata

Suction and line filters

Filtres d'aspiration et filtres en ligne

CARATTERISTICHE TECNICHE

I **filtri di aspirazione** GEOLINE vengono realizzati in polipropilene, con guarnizioni in EPDM (Viton® a richiesta), particolari metallici interni in acciaio inox AISI 304, particolari metallici esterni di fissaggio in ottone, cartucce filtranti in polipropilene con reti in acciaio inox AISI 304 o in polipropilene.

I **filtri di mandata** GEOLINE vengono realizzati in polipropilene o nylon rinforzato con fibra di vetro, ghiere in polipropilene rinforzato con fibra di vetro, guarnizioni di tenuta in EPDM (Viton® a richiesta), particolari metallici interni in acciaio inox AISI 304, cartucce filtranti in polipropilene con reti in acciaio inox AISI 304.

Filtri di aspirazione
Filtri di mandata
Filtri in ottone

TECHNICAL FEATURES

GEOLINE **suction filters** are in polypropylene, with EPDM gaskets (Viton® on demand), internal mechanical details in AISI 304 stainless steel, external fastening brass details, polypropylene filtering cartridge with AISI 304 stainless steel or polypropylene mesh.

GEOLINE **line filters** are in polypropylene or fiberglass reinforced nylon, with polypropylene back nuts, EPDM seals (Viton® on demand), internal mechanical components in AISI 304 stainless steel, polypropylene filtering cartridge with AISI 304 stainless steel mesh.

Suction filters
Line filters
Brass line filters

CARACTERISTIQUES TECHNIQUES

Les **filtres d'aspiration** GEOLINE sont en polypropylène, avec joints en EPDM (Viton® sur demande), parties intérieures mécaniques en acier inoxydable AISI 304, dispositifs de fixation extérieurs en laiton, cartouches filtrantes en polypropylène avec mailles en acier inoxydable AISI 304 ou en polypropylène.

Les **filtres en ligne** GEOLINE sont en polypropylène ou en nylon renforcé par des fibres de verre, avec des embouts en polypropylène, des joints d'étanchéité en EPDM (Viton® sur demande), des parties intérieures en acier inoxydable AISI 304 et des cartouches filtrantes en polypropylène avec mailles en acier inoxydable AISI 304.

Filtres d'aspiration
Filtres en ligne
Filtres en ligne en laiton

Legenda



Per atomizzatori
For orchard sprayers
Pour atomiseurs



Per macchine a basso volume
For low-volume spraying machines
Pour machines basse volum



Per macchine da diserbo
For crop sprayers
Pour pulverisateurs



Portata della pompa
Pump flow rate
Débit de la pompe



Portata
Flow rate
Débit



Pressione d'esercizio
Operating pressure
Pression de service



	ISO 19732:2007 colour code of filters	Tecomec colour code of filters
Nominal Mesh size	Color	Color
16	Brown red RAL 3011	YELLOW
25/30	Flame red RAL 3000	WHITE
50/60	Gentian blue RAL 5010	BLUE
80	Zinc yellow RAL 1018	GRAY
100	Traffic green RAL 6024	RED
150	Pure orange RAL 2004	-
200	Light pink RAL 3015	-

- Filtri di aspirazione e mandata
- Suction and line filters
- Filtres d'aspiration et filtres en ligne

Filtri di aspirazione con valvola per portate fino a 260 l/min

Suction filters with valve for flow rates up to 260 l/min (58 US GPM)

Filtres d'aspiration avec vanne pour debits jusqu'à 260 l/min.

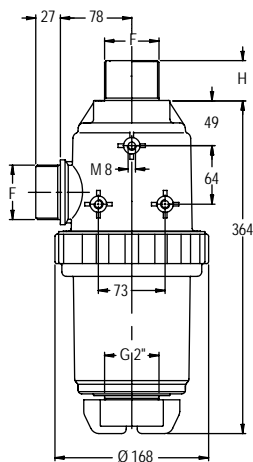

Part No.	F	Screen	H mm	Effective area cm ²	Sq.in.	Pack
8096000		INOX 32 Mesh		342	53	
8096001	2"	INOX 50 Mesh	27	314	49	8
8096002		INOX 80 Mesh		286	44	

8096003		INOX 32 Mesh		342	53	
8096004	2"	INOX 50 Mesh	44	314	49	8
8096005		INOX 80 Mesh		286	44	

Spare parts

NEW

Part No.	Screen	Gasket
C00100055	INOX 16 Mesh	G00001042
C00100046	INOX 32 Mesh	
C00100047	INOX 50 Mesh	
C00100048	INOX 80 Mesh	

Filtri di aspirazione per portate fino a 260 l/min.

Suction filters for flow rates up to 260 l/min (58 US GPM).

Filtres d'aspiration pour débits jusqu'à 260 l/min.

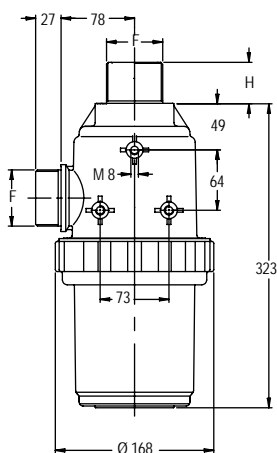

Part No.	F	Screen	H mm	Effective area cm ²	Sq.in.	Pack
8095000		INOX 32 Mesh		342	53	
8095001	2"	INOX 50 Mesh	27	314	49	8
8095002		INOX 80 Mesh		286	44	

8095003		INOX 32 Mesh		342	53	
8095004	2"	INOX 50 Mesh	44	314	49	8
8095005		INOX 80 Mesh		286	44	

Spare parts

NEW

Part No.	Screen	Gasket
C00100055	INOX 16 Mesh	G00001042
C00100046	INOX 32 Mesh	
C00100047	INOX 50 Mesh	
C00100048	INOX 80 Mesh	

Filtri di aspirazione con valvola per portate fino a 220 l/min.

Suction filters with valve for flow rates up to 220 l/min (58 US GPM).

Filtres d'aspiration avec vanne pour débits jusqu'à 220 l/min.

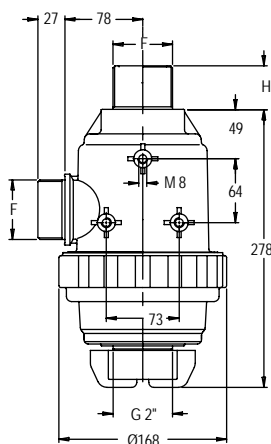

NEW

Part No.	F	Screen	H mm	Effective area cm ²	Sq.in.	Pack
8092007		INOX 16 Mesh		312	48,4	8
8092000	2"	INOX 32 Mesh		242	37,5	
8092001		INOX 50 Mesh	27	222	34,5	
8092002		INOX 80 Mesh		203	31,4	

NEW

8092008		INOX 16 Mesh		312	48,4	8
8092003	2"	INOX 32 Mesh		242	37,5	
8092004		INOX 50 Mesh	44	222	34,5	
8092005		INOX 80 Mesh		203	31,4	

Spare parts

NEW

Part No.	Screen	Gasket
C00100056	INOX 16 Mesh	G00001042
C00100008	INOX 32 Mesh	
C00100009	INOX 50 Mesh	
C00100010	INOX 80 Mesh	

Filtri di aspirazione per portate fino a 220 l/min.

Suction filters for flow rates up to 220 l/min (58 US GPM).

Filtres d'aspiration pour débits jusqu'à 220 l/min.

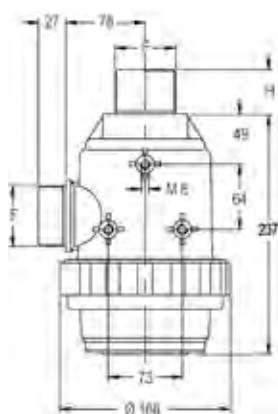

NEW

Part No.	F	Screen	H mm	Effective area cm ²	Sq.in.	Pack
8091000		INOX 32 Mesh		242	37,5	8
8091001	2"	INOX 50 Mesh	27	222	34,5	
8091002		INOX 80 Mesh		203	31,4	
8091007		INOX 16 Mesh		312	48,4	8
8091003	2"	INOX 32 Mesh		242	37,5	
8091004		INOX 50 Mesh	44	222	34,5	
8091005		INOX 80 Mesh		203	31,4	

Spare parts

NEW

Part No.	Screen	Gasket
C00100056	INOX 16 Mesh	G00001042
C00100008	INOX 32 Mesh	
C00100009	INOX 50 Mesh	
C00100010	INOX 80 Mesh	

- Filtri di aspirazione e mandata
- Suction and line filters
- Filtres d'aspiration et filtres en ligne

Filtri di aspirazione con valvola per portate fino a 180 l/min.

Suction filters with valve for flow rates up to 180 l/min (47 US GPM).

Filtres d'aspiration avec vanne pour débits jusqu'à 180 l/min.

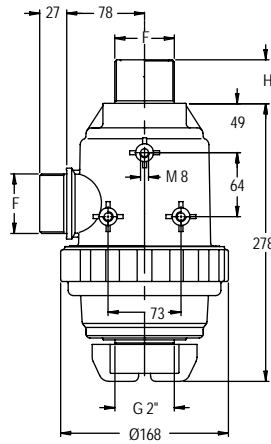

Part No.	F	Screen	H mm	Effective area cm ²	Sq.in.	Pack
8088000		INOX 32 Mesh		242	37,5	
8088001	1"1/2	INOX 50 Mesh	24	222	34,5	8
8088002		INOX 80 Mesh		203	31,4	
8088003		INOX 32 Mesh		242	37,5	
8088004	1"1/2	INOX 50 Mesh	44	222	34,5	8
8088005		INOX 80 Mesh		203	31,4	

Spare parts

NEW

Part No.	Screen	Gasket
C00100056	INOX 16 Mesh	G00001042
C00100008	INOX 32 Mesh	
C00100009	INOX 50 Mesh	
C00100010	INOX 80 Mesh	

Filtri di aspirazione per portate fino a 180 l/min.

Suction filters for flow rates up to 180 l/min (47 US GPM).

Filtres d'aspiration pour débits jusqu'à 180 l/min.

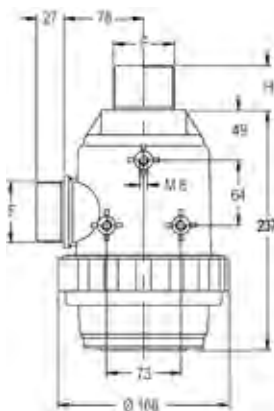

Part No.	F	Screen	H mm	Effective area cm ²	Sq.in.	Pack
8087000		INOX 32 Mesh		242	37,5	
8087001	1"1/2	INOX 50 Mesh	24	222	34,5	8
8087002		INOX 80 Mesh		203	31,4	
8087003		INOX 32 Mesh		242	37,5	
8087004	1"1/2	INOX 50 Mesh	44	222	34,5	8
8087005		INOX 80 Mesh		203	31,4	

Spare parts

NEW

Part No.	Screen	Gasket
C00100056	INOX 16 Mesh	G00001042
C00100008	INOX 32 Mesh	
C00100009	INOX 50 Mesh	
C00100010	INOX 80 Mesh	

Filtri di aspirazione con valvola per portate fino a 150 l/min.

Suction filters with valve for flow rates up to 150 l/min (40 US GPM).

Filtres d'aspiration avec vanne pour débits jusqu'à 150 l/min.

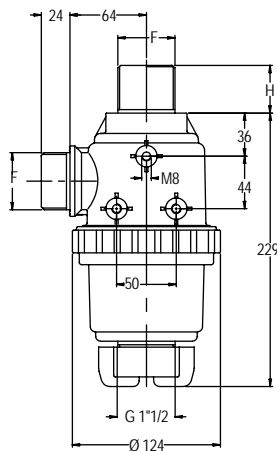

Part No.	F	Screen	H mm	Effective area cm ²	Sq.in.	Pack
8082000		INOX 32 Mesh		138	21,4	
8082001	1"1/2	INOX 50 Mesh	24	126	19,5	10
8082002		INOX 80 Mesh		115	17,8	
NEW 8082006		INOX 16 Mesh		177,8	27,6	
8082003	1"1/2	INOX 32 Mesh	40	138	21,4	10
8082004		INOX 50 Mesh		126	19,5	
8082005		INOX 80 Mesh		115	17,8	

Spare parts

NEW

Part No.	Screen	Gasket
C00100069	INOX 16 Mesh	G00001040
C00100011	INOX 32 Mesh	
C00100012	INOX 50 Mesh	
C00100013	INOX 80 Mesh	

Filtri di aspirazione per portate fino a 150 l/min.

Suction filters for flow rates up to 150 l/min (40 US GPM).

Filtres d'aspiration pour débits jusqu'à 150 l/min.

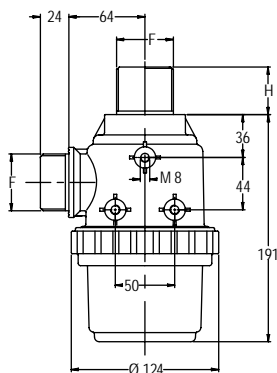

Part No.	F	Screen	H mm	Effective area cm ²	Sq.in.	Pack
8081000		INOX 32 Mesh		138	21,4	
8081001	1"1/2	INOX 50 Mesh	27	126	19,5	10
8081002		INOX 80 Mesh		115	17,8	
8081003		INOX 32 Mesh		138	21,4	
8081004	1"1/2	INOX 50 Mesh	40	126	19,5	10
8081005		INOX 80 Mesh		115	17,8	

Spare parts

NEW

Part No.	Screen	Gasket
C00100069	INOX 16 Mesh	G00001040
C00100011	INOX 32 Mesh	
C00100012	INOX 50 Mesh	
C00100013	INOX 80 Mesh	

- Filtri di aspirazione e mandata
- Suction and line filters
- Filtres d'aspiration et filtres en ligne

Filtri di aspirazione con valvola per portate fino a 150 l/min.

Suction filters with valve for flow rates up to 150 l/min (40 US GPM).

Filtres d'aspiration avec vanne pour débits jusqu'à 150 l/min.

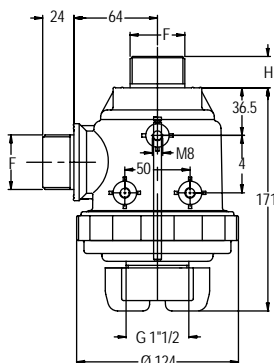

Part No.	F	Screen	H mm	Effective area cm ²	Sq.in.	Pack
8080000		INOX 32 Mesh		86	13,3	
8080001	1"1/2	INOX 50 Mesh	24	79	12,3	10
8080002		INOX 80 Mesh		72	11,2	
8080003		INOX 32 Mesh		86	13,3	
8080004	1"1/2	INOX 50 Mesh	40	79	12,3	10
8080005		INOX 80 Mesh		72	11,2	

Spare parts

Part No.	Screen	Gasket
C00100017	INOX 32 Mesh	
C00100018	INOX 50 Mesh	G00001040
C00100019	INOX 80 Mesh	

Filtri di aspirazione per portate fino a 150 l/min.

Suction filters for flow rates up to 150 l/min (40 US GPM).

Filtres d'aspiration pour débits jusqu'à 150 l/min.

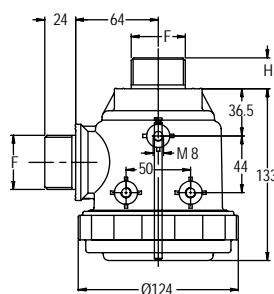

Part No.	F	Screen	H mm	Effective area cm ²	Sq.in.	Pack
8079000		INOX 32 Mesh		86	13,3	
8079001	1"1/2	INOX 50 Mesh	24	79	12,3	10
8079002		INOX 80 Mesh		72	11,2	
8079003		INOX 32 Mesh		86	13,3	
8079004	1"1/2	INOX 50 Mesh	40	79	12,3	10
8079005		INOX 80 Mesh		72	11,2	

Spare parts

Part No.	Screen	Gasket
C00100017	INOX 32 Mesh	
C00100018	INOX 50 Mesh	G00001040
C00100019	INOX 80 Mesh	

Filtri di aspirazione con valvola per portate fino a 120 l/min.

Suction filters with valve for flow rates up to 120 l/min (32 US GPM).

Filtres d'aspiration avec vanne pour débits jusqu'à 120 l/min.

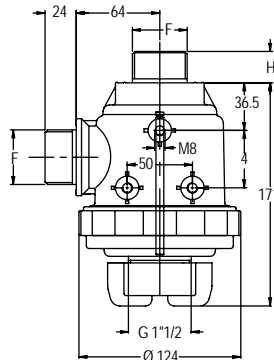

Part No.	F	Screen	H mm	Effective area cm ²	Sq.in.	Pack
8078000		INOX 32 Mesh		86	13,3	
8078001	1"1/4	INOX 50 Mesh	24	79	12,3	10
8078002		INOX 80 Mesh		72	76	
8078006		INOX 100 Mesh		76	12	
8078003		INOX 32 Mesh		86	13,3	
8078004	1"1/4	INOX 50 Mesh	40	79	12,3	10
8078005		INOX 80 Mesh		72	76	
8078007		INOX 100 Mesh		76	12	

Spare parts

	Part No.	Screen	Gasket
	C00100017	INOX 32 Mesh	G00001040
	C00100018	INOX 50 Mesh	
	C00100019	INOX 80 Mesh	
	C00100050	INOX 100 Mesh	

Filtri di aspirazione per portate fino a 120 l/min.

Suction filters for flow rates up to 120 l/min (32 US GPM).

Filtres d'aspiration pour débits jusqu'à 120 l/min.

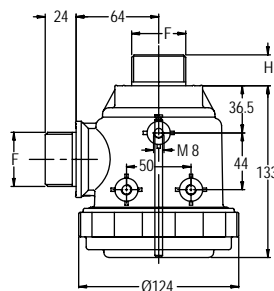

Part No.	F	Screen	H mm	Effective area cm ²	Sq.in.	Pack
8077000		INOX 32 Mesh		86	13,3	
8077001	1"1/4	INOX 50 Mesh	24	79	12,3	10
8077002		INOX 80 Mesh		72	76	
8077006		INOX 100 Mesh		76	12	
8077003		INOX 32 Mesh		86	13,3	
8077004	1"1/4	INOX 50 Mesh	40	79	12,3	10
8077005		INOX 80 Mesh		72	76	
8077007		INOX 100 Mesh		76	12	

Spare parts

	Part No.	Screen	Gasket
	C00100017	INOX 32 Mesh	G00001040
	C00100018	INOX 50 Mesh	
	C00100019	INOX 80 Mesh	
	C00100050	INOX 100 Mesh	

- Filtri di aspirazione e mandata
- Suction and line filters
- Filtres d'aspiration et filtres en ligne

Filtri di aspirazione per portate fino a 100 l/min.

Suction filters for flow rates up to 100 l/min (26 US GPM).

Filtres d'aspiration pour débits jusqu'à 100 l/min.

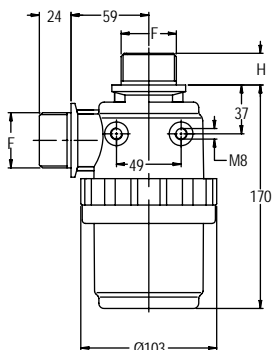

Part No.	F	Screen	H mm	Effective area cm ²	Sq.in.	Pack
8074000		INOX 32 Mesh		105	16,3	
8074001		INOX 50 Mesh		97	15	
8074002		PP 18 Mesh	24	90	14	10
8074003		PP 32 Mesh		69	10,7	
8074008	1"1/4	INOX 100 Mesh		94	14,5	
8074004		INOX 32 Mesh		105	16,3	
8074005		INOX 50 Mesh		97	15	
8074006		PP 18 Mesh	40	90	14	10
8074007		PP 32 Mesh		69	10,7	
8074009		INOX 100 Mesh		94	14,5	

Spare parts

	Part No.	Screen	Gasket
	C00100020	INOX 32 Mesh	
	C00100021	INOX 50 Mesh	
	C00100036	INOX 100 Mesh	G00001034
	C00100022	PP 18 Mesh	
	C00100023	PP 32 Mesh	

Filtri di aspirazione per portate fino a 60 l/min.

Suction filters for flow rates up to 60 l/min (16 US GPM).

Filtres d'aspiration pour débits jusqu'à 60 l/min.

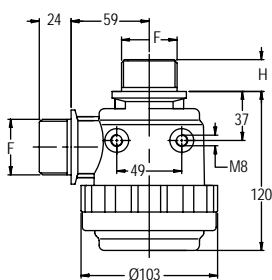

Part No.	F	Screen	H mm	Effective area cm ²	Sq.in.	Pack
8072000		INOX 32 Mesh		66	10,3	
8072001		INOX 50 Mesh		61	9,4	
8072002		PP 18 Mesh	24	56	8,7	10
8072003	1"1/4	PP 32 Mesh		43	6,7	
8072004		INOX 32 Mesh		66	10,3	
8072005		INOX 50 Mesh	40	61	9,4	10
8072006		PP 18 Mesh		56	8,7	
8072007		PP 32 Mesh		43	6,7	

Spare parts

	Part No.	Screen	Gasket
	C00100024	INOX 32 Mesh	
	C00100025	INOX 50 Mesh	
	C00100026	PP 18 Mesh	G00001034
	C00100027	PP 32 Mesh	

Filtri di mandata per pressioni di esercizio fino a 15 bar.

Line filters for pressures up to 15 bar (220 PSI).

Filtres en ligne pour pressions jusqu'à 15 bar .

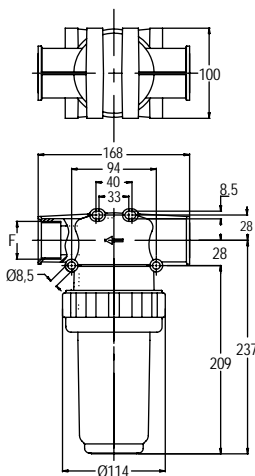

Part No.	F		Screen	Effective area		Pack
				cm ²	Sq.in.	
8121000		1/1"	INOX 32 Mesh	116	18	
8121001	1"1/4	200	INOX 50 Mesh	106	16,4	5
8121002			INOX 80 Mesh	97	15	
8121003			INOX 100 Mesh	103	16	
8121004			INOX 32 Mesh	116	18	
8121005	1"1/2	280	INOX 50 Mesh	106	16,4	5
8121006			INOX 80 Mesh	97	15	
8121007			INOX 100 Mesh	103	16	

Spare parts

	Part No.	Screen	Gasket
	C00100032	INOX 32 Mesh	G00001046
	C00100033	INOX 50 Mesh	
	C00100034	INOX 80 Mesh	
	C00100035	INOX 100 Mesh	

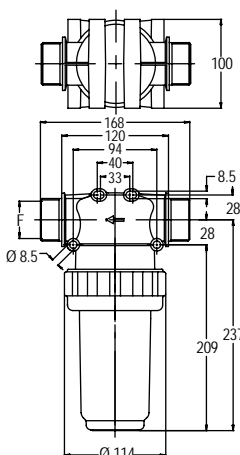

Part No.	F		Screen	Effective area		Pack
				cm ²	Sq.in.	
8127000		1/1"	INOX 32 Mesh	116	18	
8127001	1"1/4	200	INOX 50 Mesh	106	16,4	5
8127002			INOX 80 Mesh	97	15	
8127003			INOX 100 Mesh	103	16	
8127004			INOX 32 Mesh	116	18	
8127005	1"1/2	280	INOX 50 Mesh	106	16,4	5
8127006			INOX 80 Mesh	97	15	
8127007			INOX 100 Mesh	103	16	

Spare parts

	Part No.	Screen	Gasket
	C00100032	INOX 32 Mesh	G00001046
	C00100033	INOX 50 Mesh	
	C00100034	INOX 80 Mesh	
	C00100035	INOX 100 Mesh	

- Filtri di aspirazione e mandata
- Suction and line filters
- Filtres d'aspiration et filtres en ligne

Filtri di mandata per pressioni di esercizio fino a 20 bar.

Line filters with for pressures up to 20 bar (290 PSI).

Filtres en ligne pour pressions jusqu'à 20 bar.



G 1/2" - 3/4"

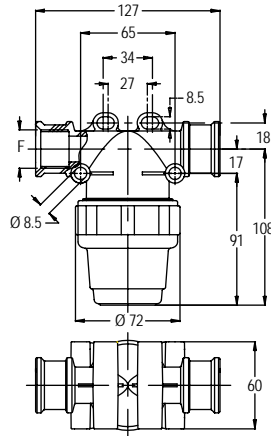

Spare parts G 1/2" - 3/4"

	Part No.	Screen	Gasket
	C00100000	INOX 32 Mesh	G00001024
	C00100001	INOX 50 Mesh	
	C00100002	INOX 80 Mesh	
	C00100003	INOX 100 Mesh	

Part No.	F		Screen	Effective area cm ²	Sq.in.	Pack
8105000	1/2"	80	INOX 32 Mesh	26	4	10
8105001			INOX 50 Mesh	24	3,7	
8105002			INOX 80 Mesh	22	3,4	
8105003			INOX 100 Mesh	23	3,6	
8105004	3/4"	100	INOX 32 Mesh	26	4	10
8105005			INOX 50 Mesh	24	3,7	
8105006			INOX 80 Mesh	22	3,4	
8105007			INOX 100 Mesh	23	3,6	
8105008	1"	150	INOX 32 Mesh	38	5,9	10
8105009			INOX 50 Mesh	35	5,4	
8105010			INOX 80 Mesh	32	5	
8105011			INOX 100 Mesh	34	5,3	



G 1"

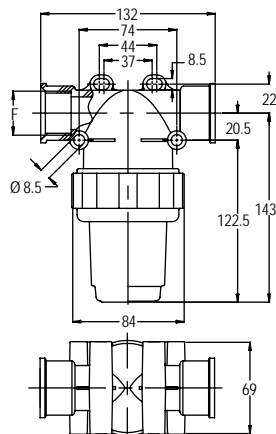

Spare parts G 1"

	Part No.	Screen	Gasket
	C00100004	INOX 32 Mesh	G00001024
	C00100005	INOX 50 Mesh	
	C00100006	INOX 80 Mesh	
	C00100007	INOX 100 Mesh	

Filtri di mandata per pressioni di esercizio fino a 20 bar.

Line filters for pressures up to 20 bar (290 PSI).

Filtres en ligne pour pressions jusqu'à 20 bar.



G 1/2" - 3/4"

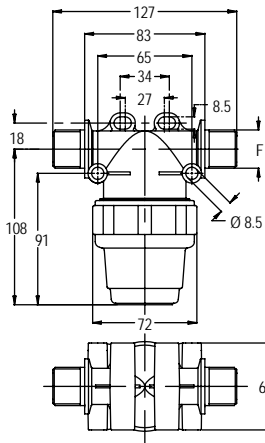

Spare parts G 1/2" - 3/4"

Part No.	Screen	Gasket
C00100000	INOX 32 Mesh	G00001024
C00100001	INOX 50 Mesh	
C00100002	INOX 80 Mesh	
C00100003	INOX 100 Mesh	

Part No.	F		Screen	Effective area		Pack
		1/1'		cm ²	Sq.in.	
8110000	1/2"	80	INOX 32 Mesh	26	4	10
8110001			INOX 50 Mesh	24	3,7	
8110002			INOX 80 Mesh	22	3,4	
8110003			INOX 100 Mesh	23	3,6	
8110004	3/4"	100	INOX 32 Mesh	26	4	10
8110005			INOX 50 Mesh	24	3,7	
8110006			INOX 80 Mesh	22	3,4	
8110007			INOX 100 Mesh	23	3,6	
8110008	1"	150	INOX 32 Mesh	38	5,9	10
8110009			INOX 50 Mesh	35	5,4	
8110010			INOX 80 Mesh	32	5	
8110011			INOX 100 Mesh	34	5,3	



G 1"

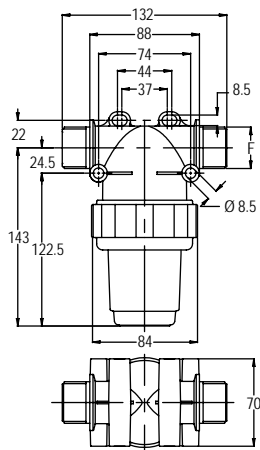

Spare parts G 1"

Part No.	Screen	Gasket
C00100004	INOX 32 Mesh	G00001024
C00100005	INOX 50 Mesh	
C00100006	INOX 80 Mesh	
C00100007	INOX 100 Mesh	



- Filtri di aspirazione e mandata
- Suction and line filters
- Filtres d'aspiration et filtres en ligne

Filtri di mandata autopulenti per pressioni di esercizio fino a 15 bar con filetti femmina.

Self-cleaning line filters for pressures up to 15 bar (250 PSI) - female threads.

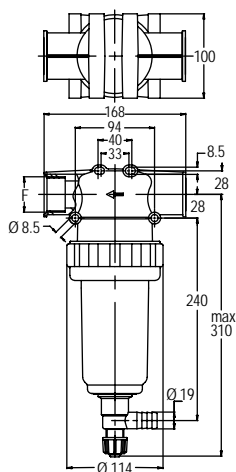
Filtres en ligne autonettoyants pour pressions jusqu'à 15 bar - filetage femelle.



Part No.	F		Screen	Effective area		Pack
				cm ²	Sq.in.	
8122000			INOX 32 Mesh	116	18	
8122001	1"1/4	200	INOX 50 Mesh	106	16,4	5
8122002			INOX 80 Mesh	97	15	
8122003			INOX 100 Mesh	103	16	
8122004			INOX 32 Mesh	116	18	
8122005	1"1/2	280	INOX 50 Mesh	106	16,4	5
8122006			INOX 80 Mesh	97	15	
8122007			INOX 100 Mesh	103	16	

Spare parts



	Part No.	Screen	Gasket
	C00100032	INOX 32 Mesh	G00001046
	C00100033	INOX 50 Mesh	
	C00100034	INOX 80 Mesh	
	C00100035	INOX 100 Mesh	

Filtri di mandata autopulenti per pressioni di esercizio fino a 15 bar con filetti maschio.

Self-cleaning line filters for pressures up to 15 bar (220 PSI) - male threads.

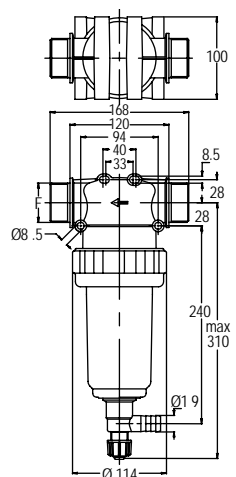
Filtres en ligne autonettoyants pour pressions jusqu'à 15 bar - filetage mâle.



Part No.	F		Screen	Effective area		Pack
				cm ²	Sq.in.	
8128000			INOX 32 Mesh	116	18	
8128001	1"1/4	200	INOX 50 Mesh	106	16,4	5
8128002			INOX 80 Mesh	97	15	
8128003			INOX 100 Mesh	103	16	
8128004			INOX 32 Mesh	116	18	
8128005	1"1/2	280	INOX 50 Mesh	106	16,4	5
8128006			INOX 80 Mesh	97	15	
8128007			INOX 100 Mesh	103	16	

Spare parts

	Part No.	Screen	Gasket
	C00100032	INOX 32 Mesh	G00001046
	C00100033	INOX 50 Mesh	
	C00100034	INOX 80 Mesh	
	C00100035	INOX 100 Mesh	

Filtri di mandata autopulenti per pressioni di esercizio fino a 20 bar con filetti femmina.

Self-cleaning line filters for pressures up to 20 bar (290 PSI) - female threads.

Filtres en ligne autonettoyants pour pressions jusqu'à 20 bar - filetage femelle.

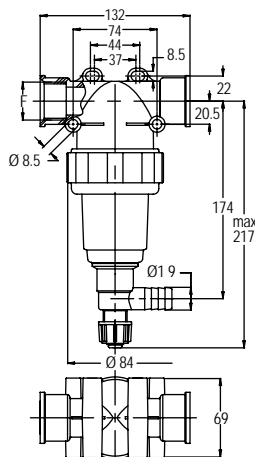

Part No.	F	1/1'	Screen	Effective area		Pack
				cm ²	Sq.in.	
8106000	1"	150	INOX 32 Mesh	38	5,9	10
8106001			INOX 50 Mesh	35	5,4	
8106002			INOX 80 Mesh	32	5	
8106003			INOX 100 Mesh	34	5,3	

Spare parts

	Part No.	Screen	Gasket
	C00100004	INOX 32 Mesh	G00001024
	C00100005	INOX 50 Mesh	
	C00100006	INOX 80 Mesh	
	C00100007	INOX 100 Mesh	

Filtri di mandata autopulenti per pressioni di esercizio fino a 20 bar con filetti maschio.

Self-cleaning line filters for pressures up to 20 bar (290 PSI) - male threads.

Filtres en ligne autonettoyants pour pressions jusqu'à 20 bar - filetage mâle.

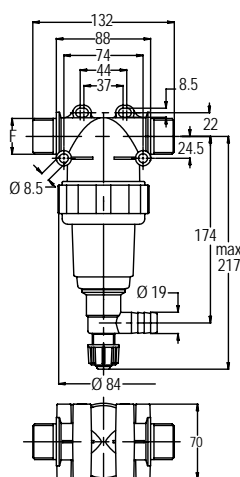

Part No.	F	1/1'	Screen	Effective area		Pack
				cm ²	Sq.in.	
8111000	1"	150	INOX 32 Mesh	38	5,9	10
8111001			INOX 50 Mesh	35	5,4	
8111002			INOX 80 Mesh	32	5	
8111003			INOX 100 Mesh	34	5,3	

Spare parts

	Part No.	Screen	Gasket
	C00100004	INOX 32 Mesh	G00001024
	C00100005	INOX 50 Mesh	
	C00100006	INOX 80 Mesh	
	C00100007	INOX 100 Mesh	

- Filtri di aspirazione e mandata
- Suction and line filters
- Filtres d'aspiration et filtres en ligne

Filtri di mandata per pressioni di esercizio fino a 10 bar (220 PSI). Con filetti femmina.

Line filters for pressures up to 10 bar (145 PSI). Female threads.

Filtres en ligne pour pressions jusqu'à 10 bar (220 PSI). Filetage femelle.

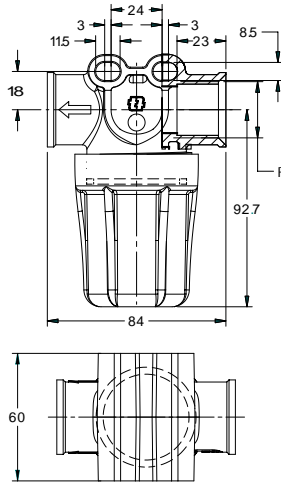

Part No.	F	I/1'	Screen	Effective area		Pack
				cm ²	Sq.in.	
8105024	G 3/4"	55	INOX 32 Mesh	25,6	4.0	10
8105025			INOX 50 Mesh	23,5	3.6	
8105026			INOX 80 Mesh	25,6	4.0	
8105027			INOX 100 Mesh	21,5	3.3	
8105032	G 1/2"	55	INOX 32 Mesh	25,6	4.0	10
8105033			INOX 50 Mesh	23,5	3.6	
8105034			INOX 80 Mesh	25,6	4.0	
8105035			INOX 100 Mesh	21,5	3.3	

Spare parts

	Part No.	Screen	Gasket
	C00100057	INOX 32 Mesh	G00002052
	C00100058	INOX 50 Mesh	
	C00100059	INOX 80 Mesh	
	C00100060	INOX 100 Mesh	

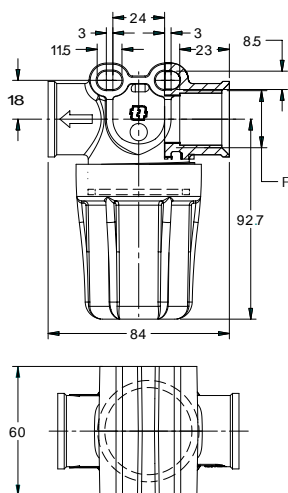

Part No.	F	I/1'	Screen	Effective area		Pack
				cm ²	Sq.in.	
8105040	G 3/4"	55	INOX 32 Mesh	25,6	4.0	10
8105041			INOX 50 Mesh	23,5	3.6	
8105042			INOX 80 Mesh	25,6	4.0	
8105043			INOX 100 Mesh	21,5	3.3	
8105036	G 1/2"	55	INOX 32 Mesh	25,6	4.0	10
8105037			INOX 50 Mesh	23,5	3.6	
8105038			INOX 80 Mesh	25,6	4.0	
8105039			INOX 100 Mesh	21,5	3.3	

Spare parts

	Part No.	Screen	Gasket
	C00100057	INOX 32 Mesh	G00002052
	C00100058	INOX 50 Mesh	
	C00100059	INOX 80 Mesh	
	C00100060	INOX 100 Mesh	

Filtri di mandata per pressioni di esercizio fino a 15 bar (220 PSI). Con filetti maschio.

Line filters for pressures up to 15 bar (220 PSI). With male threads.

Filtres en ligne pour pressions jusqu'à 15 bar (220 PSI). Avec filetage mâle.

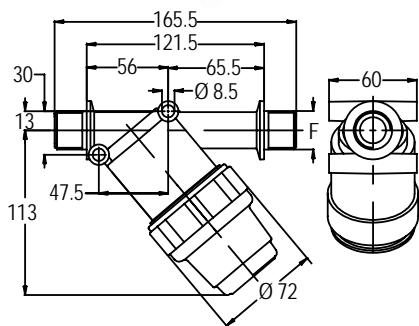

Part No.	F	I/I'	Screen	Effective area		Pack
				cm ²	Sq.in.	
8118000	1/2"	80	INOX 32 Mesh	38	5,9	10
8118001			INOX 50 Mesh	35	5,4	
8118002			INOX 80 Mesh	32	5	
8118003			INOX 100 Mesh	34	5,3	
8118004	3/4"	100	INOX 32 Mesh	38	5,9	10
8118005			INOX 50 Mesh	35	5,4	
8118006			INOX 80 Mesh	32	5	
8118007			INOX 100 Mesh	34	5,3	
8118008	1"	150	INOX 32 Mesh	38	5,9	10
8118009			INOX 50 Mesh	35	5,4	
8118010			INOX 80 Mesh	32	5	
8118011			INOX 100 Mesh	34	5,3	

Spare parts

	Part No.	Screen	Gasket
		C00100004	INOX 32 Mesh
C00100005		INOX 50 Mesh	
C00100006		INOX 80 Mesh	
C00100007		INOX 100 Mesh	

Filtri di mandata per portate fino a 260 l/min. Con filetti maschio.

Line filters for flow rates up to 260 l/min (68 US GPM). With male threads.

Filtres en ligne pour debits jusqu'à 260 l/min. Avec filetage mâle.

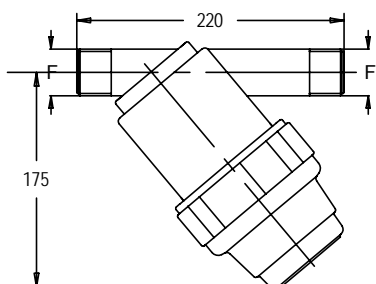

Part No.	F	bar	Pack
8118014	1" 1/2	8	5

Spare parts

Part No.	Screen
C00100062	PET 120 Mesh

- Filtri di aspirazione e mandata
- Suction and line filters
- Filtres d'aspiration et filtres en ligne

Filtri di mandata per portate fino a 600 l/min.
Con filetti maschio.

Line filters for flow rates up to 600 l/min
(16 0 US GPM). With male threads.

Filtres en ligne pour debits jusqu'à 600 l/
min. Avec filetage mâle.

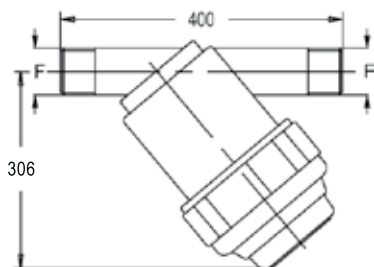

Part No.	F	Screen	 bar	Pack
8118017	2"	INOX BAG 30 Mesh	8	5
8118019	2"	INOX BAG 50 Mesh	8	5
8118013	2"	POLY BAG 120 Mesh	8	5

Spare parts





Part No.	Screen	Gasket
R00201059	POLY BAG 120 Mesh	G00000025

Filtri di mandata per portate fino a 800 l/min.
Con filetti maschio.

Line filters for flow rates up to 800 l/min
(211 US GPM). With male threads.

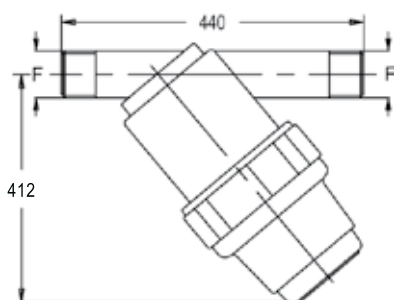
Filtres en ligne pour debits jusqu'à 800 l/
min. Avec filetage mâle.



Part No.	F	Screen	 bar	Pack
8118018	3"	INOX BAG 30 Mesh	8	5
8118020	3"	INOX BAG 50 Mesh	8	5
8118012	3"	POLY BAG 120 Mesh	8	5

Spare parts



Part No.	Screen	Gasket
R00201060	POLY BAG 120 Mesh	G00000026

Filtri galleggianti di aspirazione

- Filtro galleggiante realizzato in materiale plastico antiurto.
- Il raccordo girevole (da ordinare a parte) garantisce un perfetto galleggiamento del filtro anche con tubo di collegamento attorcigliato.

Floating filters

- Suction floating filter in shock-resistant plastic.
- The swivel fitting (to be ordered separately) assures the perfect floating even in case of twisted pipe.

Filtres flottants d'aspiration

- Filtre flottant d'aspiration fabriqué en plastique antichoc.
- Le raccord tournant (à commander séparément) assure le flottement parfait du filtre, même en cas de tuyau d'aspiration entortillé.

Ordinare il raccordo separatamente >>
Fitting to be ordered separately >>
Commander le raccord séparément >>

Part No.	F	Pack
R0000020	33	5
R0000021	35	
R0000022	40	
R0000023	50	



Part No.	Pack
8062003	5

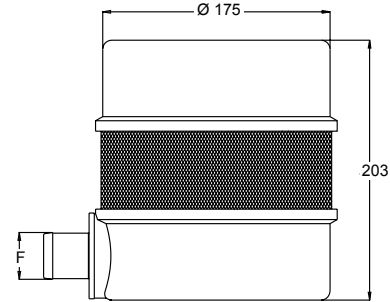

Cestini di fondo.



Foot filters.

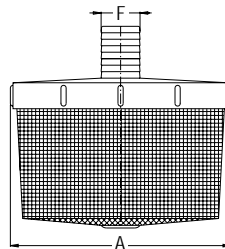

Filtres de fond.

Part No.	F	F1	Type	Pack
8060000	100	15		25
8060001	100	20		25
8060002	137	20		25
8060003	137	25		25
8060004	137	30		10
8060005	137	30		10
8060006	137	35		10
8060007	137	40		10

Filtri di aspirazione per detergente (con contrappeso).



Suction filters for detergents (with counterweight).

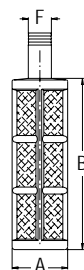

Filtres d'aspiration pour détergents (avec contreponds).

Part No.	F	A	B	Pack
8064000	8	22	40	10
* 8064001	8+VALV.	22	40	10

* Fino ad esaurimento
Selling out
Jusqu'à épuisement

Filtri di aspirazione



Suction filters

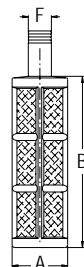

Filtres d'aspiration

Part No.	F	A	B	Pack
8064002	19	42	65	10
8064003	25	42	65	10

- Filtri di aspirazione e mandata
- Suction and line filters
- Filtres d'aspiration et filtres en ligne

Filtri in linea flangiati con spurgo per gruppi di comando manuali ed elettrici serie PILOT.

Flanged line filters with drain valve for manual and electric control units PILOT.

Filtres en ligne bridés et avec vanne de nettoyage pour groupes de commande manuels et électriques PILOT.

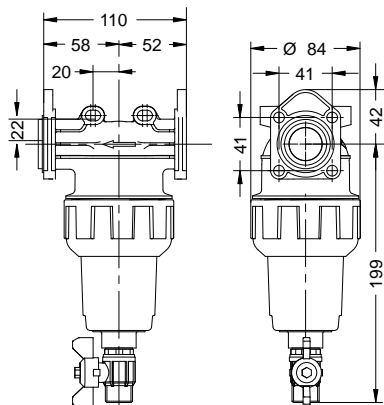

Part No.	Screen	bar	l/1'	Pack
8125007	INOX 32 Mesh			
8125008	INOX 50 Mesh	50	150	4
8125009	INOX 80 Mesh			

Spare parts

	Part No.	Screen	Gasket
	C00100004	INOX 32 Mesh	
	C00100005	INOX 50 Mesh	G00001024
	C00100006	INOX 80 Mesh	

Filtri in linea attacco rapido con spurgo per gruppi di comando manuali ed elettrici.

Quick connection line filters with drain valve for manual and electric control units.

Filtres en ligne raccord rapide avec vanne de nettoyage pour groupes de commande manuels et électriques.

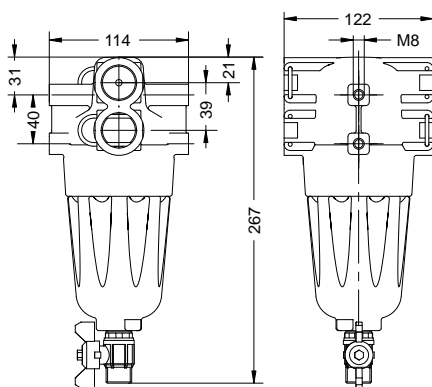

Part No.	Screen	bar	l/1'	Pack
8135004	INOX 32 Mesh			
8135005	INOX 50 Mesh	50	150	4
8135006	INOX 80 Mesh			

Spare parts

	Part No.	Screen	Gasket
	C00100014	INOX 32 Mesh	
	C00100015	INOX 50 Mesh	G00001040
	C00100016	INOX 80 Mesh	

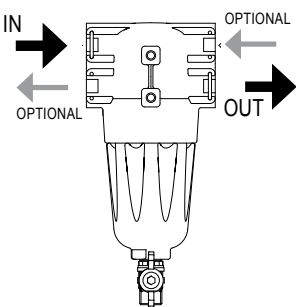

ACCESSORIES

MAX 50 bar

Ottone / Brass / Laiton

Part No.	Ø
R00000066	G 1/2" M
R00000110	G 3/4" M

Part No.
T00000018
T00000034

MAX 20 bar

Part No.	Ø mm
R00000014	10
R00000015	13
R00000016	16
R00000017	19

Part No.	Ø
R00000083	G 3/4" M

Part No.	Ø
T00000018	

Part No.	Ø mm
R00000082	13

Part No.	Ø
R00000084	G 3/4" F
R00000085	NPT 3/4" F

Filtri di mandata per portate fino a 150 l/min e pressioni fino a 50 bar.

Line filters for flow rates up to 150 l/min (40 US GPM) and pressure up to 50 bar (720 PSI).

Filtres en ligne pour débits jusqu'à 150 l/min et pressions jusqu'à 50 bar.

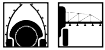

NEW

Part No.	F	Screen	Effective area		Pack
			cm ²	Sq.in.	
8135000		INOX 32 Mesh	70	10,9	4
8135001	3/4"	INOX 50 Mesh	64	10	
8135002		INOX 80 Mesh	59	9,1	
8135009		INOX 100 Mesh	59,2	9,2	

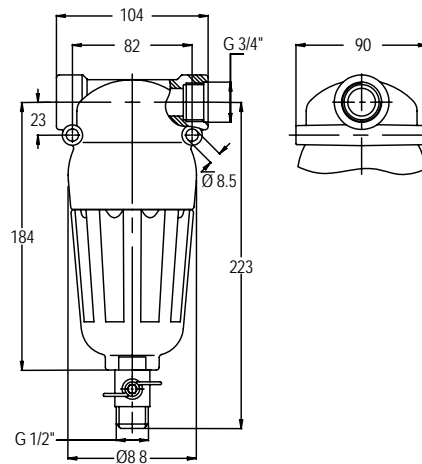

Spare parts

NEW

Part No.	Screen	Gasket
C00100015	INOX 50 Mesh	
C00100016	INOX 80 Mesh	
C00100073	INOX 100 Mesh	

Tappo in ottone.

Brass plug.

Bouchon en laiton.

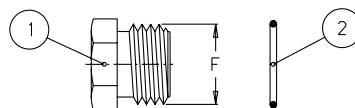

Part No. 1	Part No. 2	F	Pack
8304000	G00001058	G 3/4"	10

Nipplo in ottone.

Brass nipple.

Adaptateur en laiton.

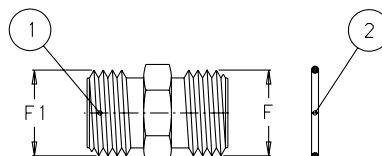

Part No. 1	Part No. 2	F	F1	Pack
8304001	G00001058	G 3/4"	G 1/2"	10
8304002	G00001058	G 3/4"	G 3/4"	10

- Filtri di aspirazione e mandata
- Suction and line filters
- Filtres d'aspiration et filtres en ligne

Filtri di mandata in ottone per portate fino a 70 l/min e pressioni fino a 50 bar.

Brass line filters for flow rates up to 70 l/min (18.5 US GPM) and pressure up to 50 bar (720 PSI).

Filtres en ligne en laiton pour débits jusqu'à 70 l/min et pressions jusqu'à 50 bar.

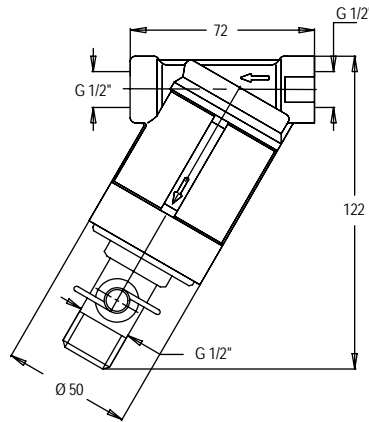

Part No.	F	Screen	Pack
8137009		INOX 30 Mesh	
8137008	1/2"	INOX 40 Mesh	5
8137010		INOX 70 Mesh	

Spare parts

	Part No.	Screen
	C00100051	INOX 30 Mesh
	C00100042	INOX 40 Mesh
	C00100052	INOX 70 Mesh

Filtri di mandata in ottone per portate fino a 70 l/min e pressioni fino a 50 bar.

Brass line filters for flow rates up to 70 l/min (18.5 US GPM) and pressure up to 50 bar (720 PSI).

Filtres en ligne en laiton pour débits jusqu'à 70 l/min et pressions jusqu'à 50 bar.

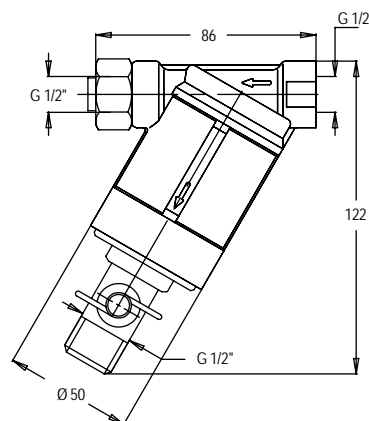

Part No.	F	Screen	Pack
8137011		INOX 30 Mesh	
8137004	1/2"	INOX 40 Mesh	5
8137012		INOX 70 Mesh	

Spare parts

	Part No.	Screen
	C00100051	INOX 30 Mesh
	C00100042	INOX 40 Mesh
	C00100052	INOX 70 Mesh

Filtri di mandata in ottone per portate fino a 150 l/min e pressioni fino a 50 bar.

Brass line filters for flow rates up to 150 l/min (40 US GPM) and pressure up to 50 bar (720 PSI).

Filtres en ligne en laiton pour débits jusqu'à 150 l/min et pressions jusqu'à 50 bar.

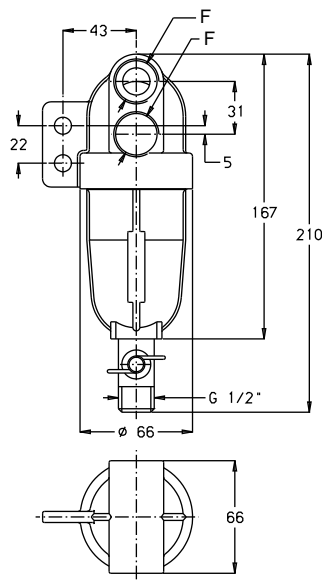

Part No.	F	Screen	Effective area cm ²	Sq.in.	Pack
8137006		INOX 30 Mesh			
8137007	G 3/4"	INOX 40 Mesh	145	22	
8137015		INOX 80 Mesh			
8137016		INOX 100 Mesh			4
8137013		INOX 30 Mesh			
8137014	G 1/2"	INOX 40 Mesh	145	22	
8137017		INOX 80 Mesh			
8137018		INOX 100 Mesh			

Spare parts

Part No.	Screen
C00100043	INOX 30 Mesh
C00100044	INOX 40 Mesh
C00100053	INOX 80 Mesh
C00100054	INOX 100 Mesh

Filtro a siluro per portate fino a 110 l/min e pressioni fino a 50 bar.

"Torpedo" filter for flow rates up to 110 l/min (29 US GPM), max. pressure 50 bar (720 PSI).

Filtre à "torpille" pour débit jusqu'à 110 l/min et pressions jusqu'à 50 bar.

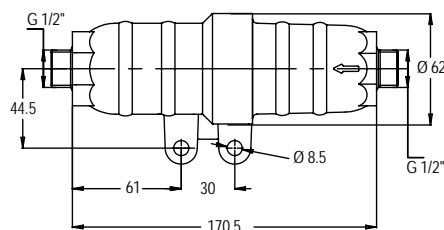

Part No.	F	Screen	Pack
8137005		INOX 40 Mesh	4

Spare parts

Part No.	Screen
C00100041	INOX 40 Mesh